



SERVICE DIVISION

DEALER TRAINING

AID #

S1014

SUBJECT:

ENGINE

MODEL:

TRIUMPH TR7

AUSTIN

JAGUAR

MG

LAND ROVER

TRIUMPH

INTRODUCTION

The engine fitted to the TR7 is an in-line four cylinder of slant configuration with an overhead camshaft and aluminum alloy cylinder head. The cylinder block is cast iron and has a five main bearing crankshaft. Over 200,000 units have already been manufactured and are in use in various British Leyland models.

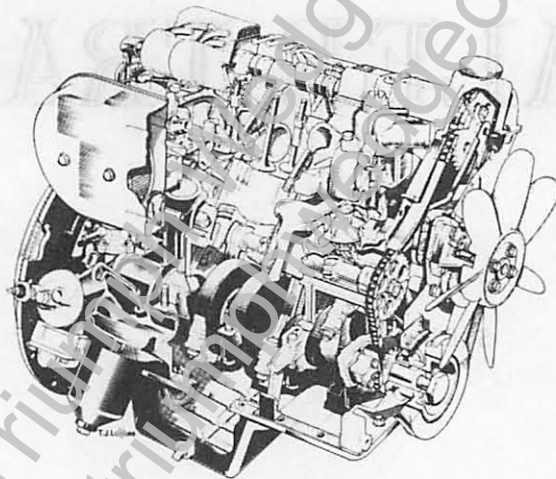

LUBRICATION

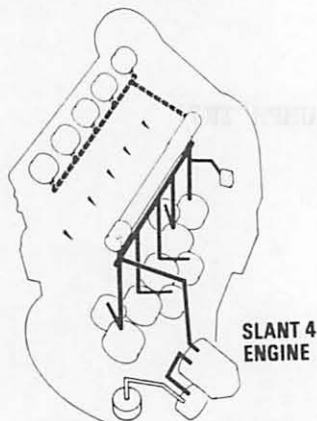

SPECIFICATIONS

Capacity	1998cc (122 cu. in.)
Bore	3.56"
Stroke	3.071"
Compression Ratio	8.0:1
Maximum Power-Net	90 at 5,000 r.p.m.
Maximum Torque-Net	105 lbs/ft. at 3,000 r.p.m.
Firing Order	1-3-4-2
Engine Number Prefix	CI4
Valve Seat Angle	45°
Valve Clearance	Inlet .008" Exhaust .018" Cold
Oil Pressure	45-55 lb/in ² at running temperature

TORQUE SPECIFICATIONS

Cylinder Head Nuts & Bolts	45-55 lbs/ft.
Camshaft Bearing Cap Nuts	10-14 lbs/ft.
Timing Wheel Bolts	7-10 lbs/ft.
Oil Pump Bolts	15-20 lbs/ft.
Oil Transfer Housing Bolt	26-32 lbs/ft.
Main Bearing Bolts	50-65 lbs/ft.
Rod Bearing Nuts	40-45 lbs/ft.
Flywheel Bolts	40-45 lbs/ft.

DISMANTLE

1. Remove air manifold and supply hose.
2. Remove air pump and diverter valve complete with adjusting bracket.
3. Remove distributor cap and wires.
4. Remove positive crankcase ventilation hose.
5. Remove fan blades and air pump drive belt.
6. Remove alternator and drive belt.
7. Remove cam cover, (note gauze inside cover should be cleaned every 12,500 miles).
8. Remove one cam bearing nut - fit to timing wheel and tighten.
9. Release timing wheel lock tabs. Rotate engine to T.D.C. firing on #1. Rotate further until bottom timing wheel bolt can be removed. Rotate further until back to the T.D.C. #1 position.
10. T.D.C. is when the camshaft and crankshafts are aligned as illustrated and the flywheel mark aligns with the mark on engine backplate.

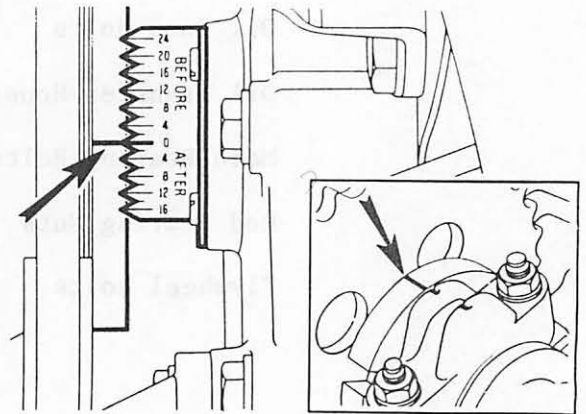
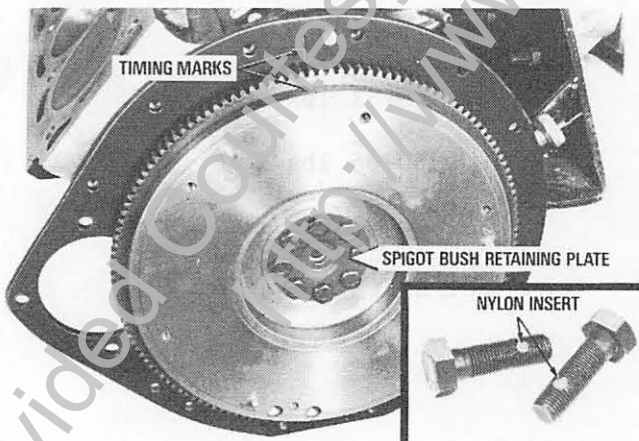

11. Remove remaining timing wheel bolt and lock plate.
12. Remove 2 nuts and bolts from front/bottom of cylinder head.
13. Slacken off all cylinder head nuts and bolts. Fit two slave studs to holes containing shortest cylinder head bolts.
14. Remove all studs complete with washers and nuts and all bolts.
15. Disconnect heater pipe at intake manifold union.
16. Lift off cylinder head. Ensure air injection tubes are retrieved.
17. Remove air pump bracket.
18. Remove fan pulley bracket.
19. Remove alternator bracket.
20. Remove crankshaft pulley.
21. Remove 2 front pan bolts.
22. Remove remaining bolts from timing cover. Note bolt in center has a fibre washer to prevent oil leakage.
23. Remove timing chain automatic tensioner. The tensioner also lubricates the chain from an oil feed from the main gallery through the tensioner pad.
24. Remove timing chain guides, chain and timing wheel bracket. Note spring and plain washer on bolt for adjustable guide.
25. Remove distributor.
26. Remove fuel pump.
27. Remove water pump using two large open ended wrenches and locking jackshaft.
28. Remove jackshaft retainer plate Allen screws and withdraw jackshaft.
29. Remove oil pan.
30. Remove oil pump.

SUB-ASSEMBLIES

CYLINDER HEAD

When removing camshaft, cam bearing caps must be released by equal amounts. The front cam bearing cap has the timing mark indentations - the remaining caps are numbered 2 through 4. Corresponding numbers are cast into the head.

Oil feed from the block is fed through the front inlet manifold side of the head which aligns with a cross drilled gallery feeding each camshaft journal.

The cams of the camshaft are slightly offset to ensure rotation of the cam followers. Tappet adjustment is accomplished by various sized pallets. Valve springs are all the same, however, the closed coil goes to the cylinder head.

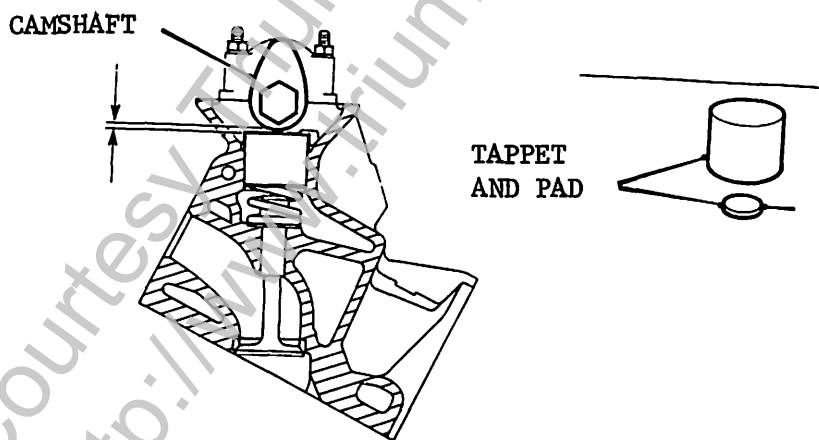

Both inlet and exhaust valve guides are the same. Replacements come .002" oversized and must be reamed after fitting.

INLET MANIFOLD

The inlet manifold is water heated. The manifold gasket has a copper insert around the exhaust gas recirculation feed to the EGR valve.

The thermostat is positioned in top of the manifold. The cover contains the cooling system filler plug. The thermostat is a double acting type. When open (hot), the radiator bypass is closed. When closed, the radiator bypass is open.

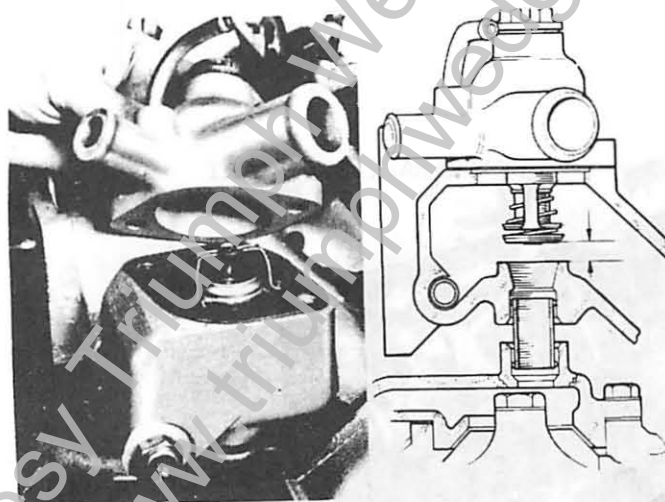

EXHAUST MANIFOLD

The manifold is a face to face joint at the head using no gaskets.

CYLINDER BLOCK AND CRANKSHAFT

The cylinder block is cast iron and has five main bearings. The crankshaft is a single cross drilled type. Crankshaft end float is controlled by thrust washers fitted into the crankcase above and either side of the center main. The end float limits are .003" - .011". Thrust washers are available .005" oversize.

The center main bearing cap overlaps the thrust washers and prevents rotation.

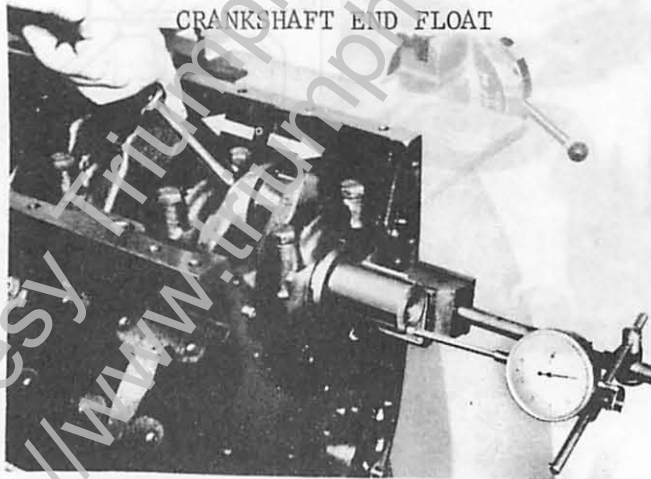

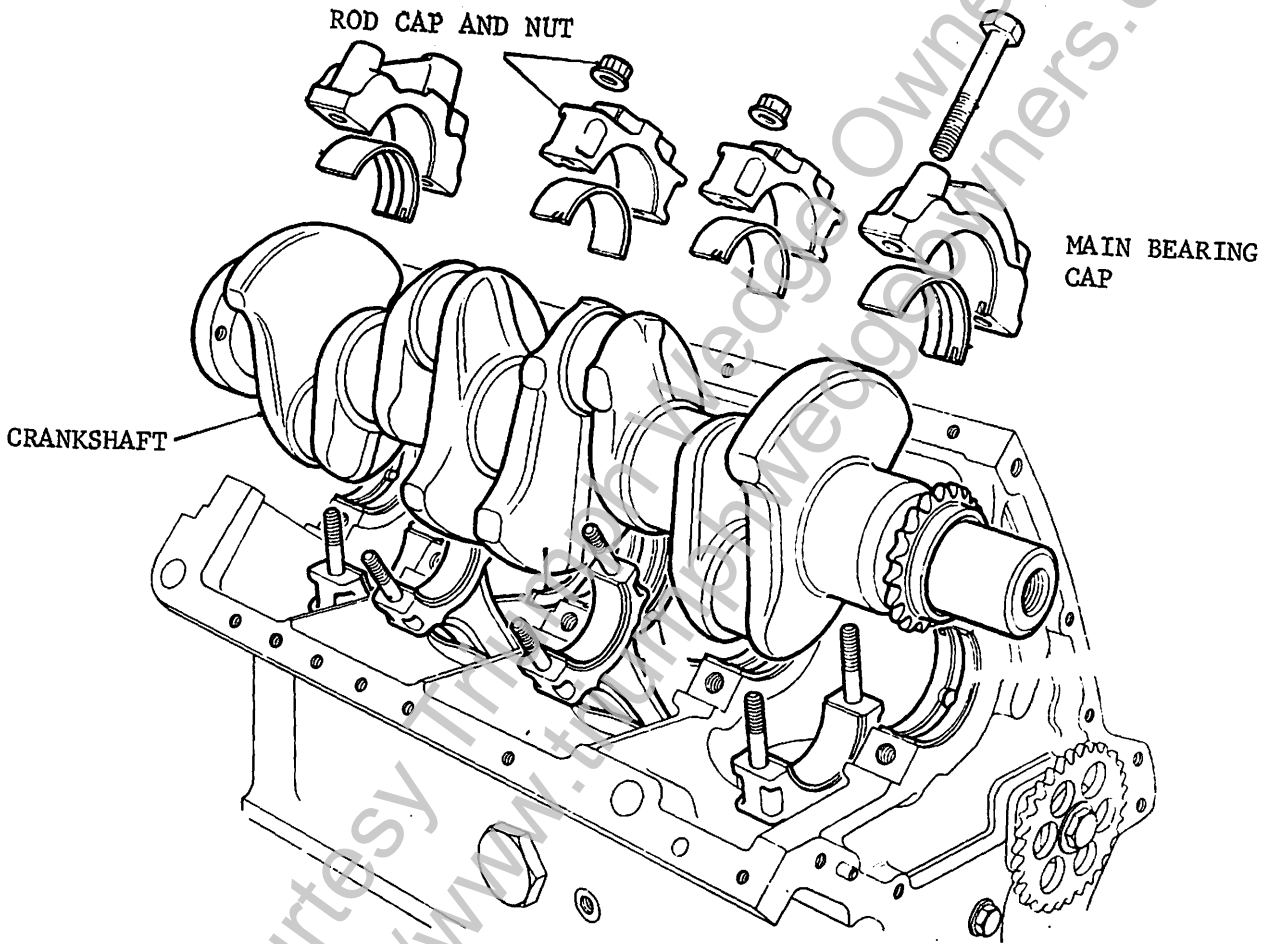

THE CRANKSHAFT GEAR

Is located by a woodruff key and must be shimmed to align with the jackshaft. Shims are available in two sizes: .004" and .006".

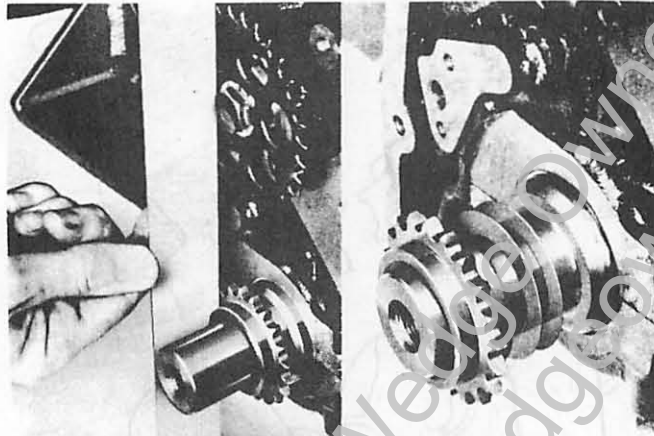

CHAIN SPROCKET ALIGNMENT

THE FLYWHEEL

Is located by eight bolts. To retain the correct T.D.C. mark alignment, the flywheel must be marked when removing as there is no dowel.

The bolts have nylon inserts and must be renewed when refitting flywheel.

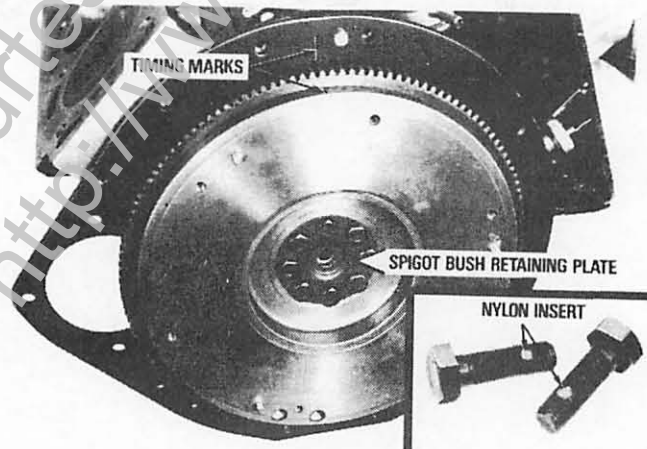

THE BLOCK REAR PLATE

Is doweled to the block. The rear crankshaft seal is retained in its own housing.

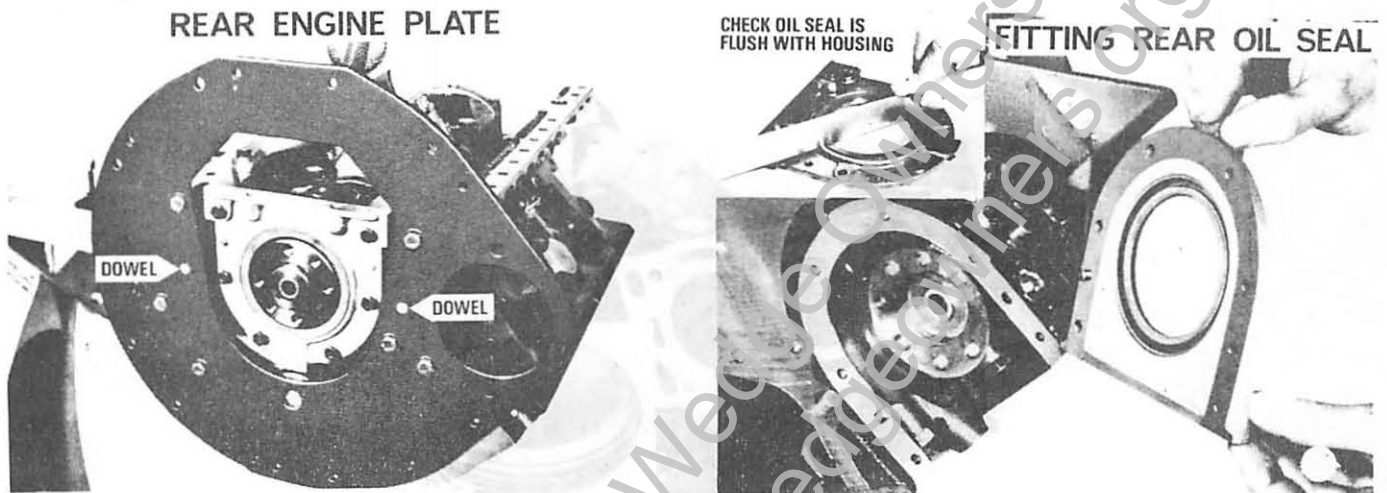

PISTONS AND RODS

The con rods and caps are numbered to each other and 1 through 4. The wrist pins are fully floating and offset. The pistons are marked front with an arrow

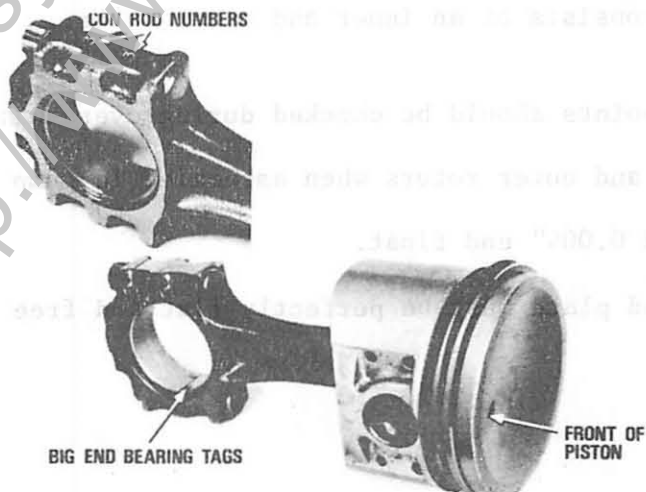

and are grade stamped either F or G, the difference being .0004". Replacement pistons are supplied .001" over the largest grade. The grade is also marked on the cylinder block.

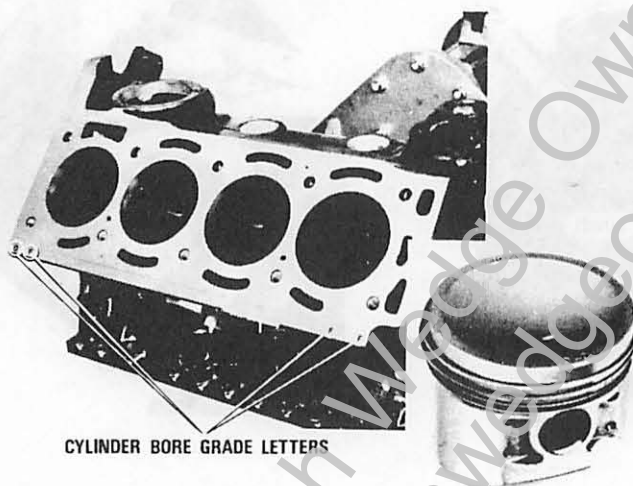

OIL PUMP AND RELIEF VALVE

The oil pump is driven via a hexagon bar from the distributor by the jackshaft and consists of an inner and outer rotor.

The following points should be checked during overhaul:

- a. Inner and outer rotors when assembled in pump body, must not exceed 0.004" end float.
- b. The end plate must be perfectly flat and free from scores.

- c. The clearance between outer rotor and pump body must not exceed 0.008".
- d. The clearance between inner and outer rotors is most important and must not exceed .010".

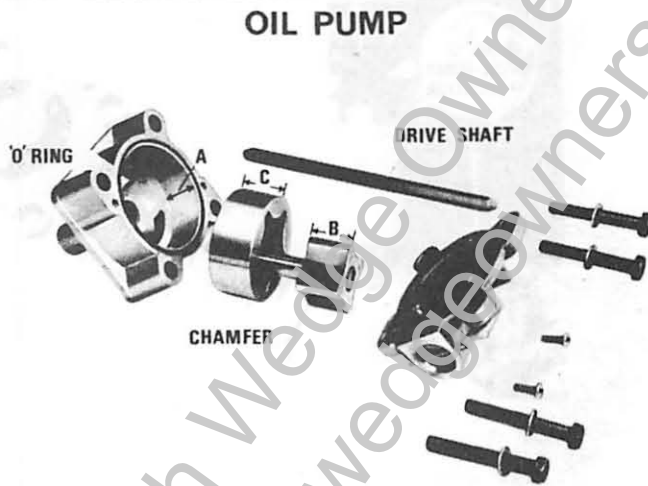

**CHECKING CLEARANCE ON
OIL PUMP ROTOR**



The oil pressure at normal running temperature should be 45-55 psi.
An 'O' ring seals the pump to engine block, The pressure relief valve
is fitted in the pump base plate.

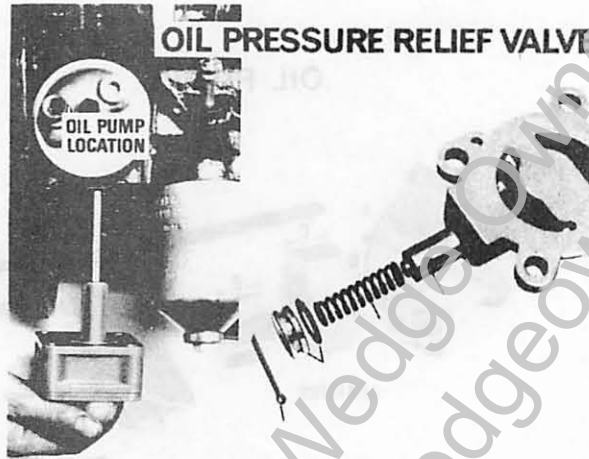

OIL TRANSFER HOUSING

The transfer housing is secured by a single bolt and sealed by two 'O' rings. It contains the oil pressure switch. Oil is picked up through the pickup pipe to pump. This feeds the full flow filter. Oil is fed from the filter to the transfer housing which forms the oil feed to the main gallery.

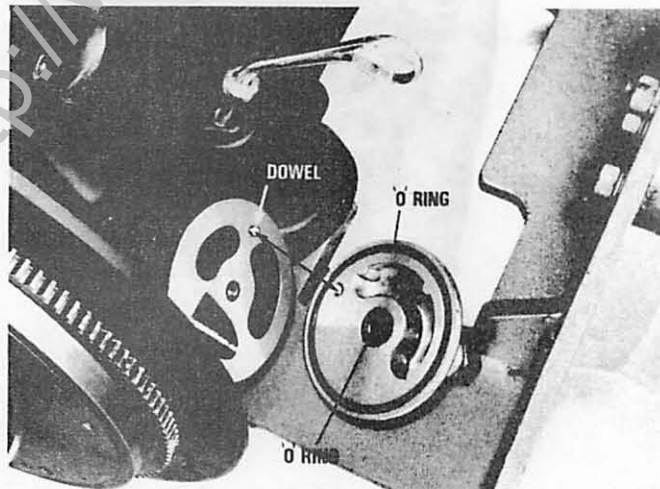

31. Refit oil pump.
32. Refit oil pan loosely.
33. Refit jackshaft and retainer plate.

Also check alignment of jackshaft to crankshaft gear. If necessary, adjust by shimming crankshaft gear.

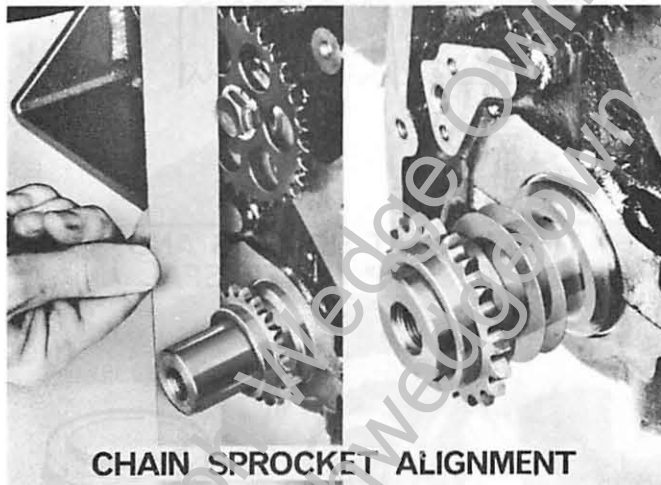

34. Refit water pump using two large open ended wrenches. Fit water pump housing finger tight (less gaskets). Take a measurement around the flange and add .015" - .020" clearance. Gaskets are available in .010" - .020" and .030" sizes.

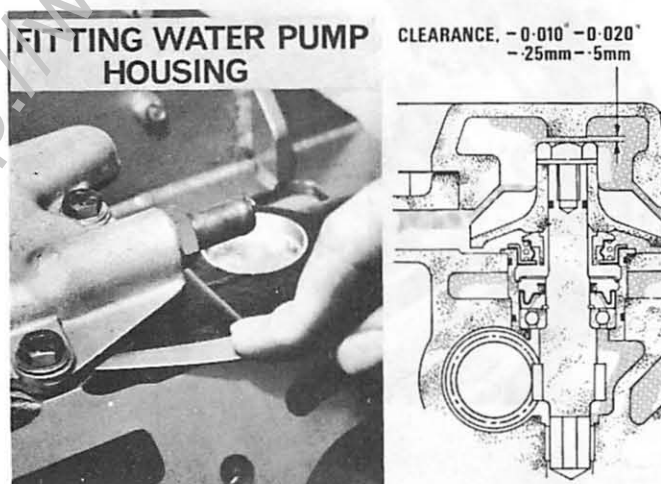

35. Refit fuel pump.

36. Refit cylinder head using slave studs as guides. Ensure camshaft timing marks are aligned. Also install 'bobbin' between inlet manifold and water pump housing.

GUIDE STUD

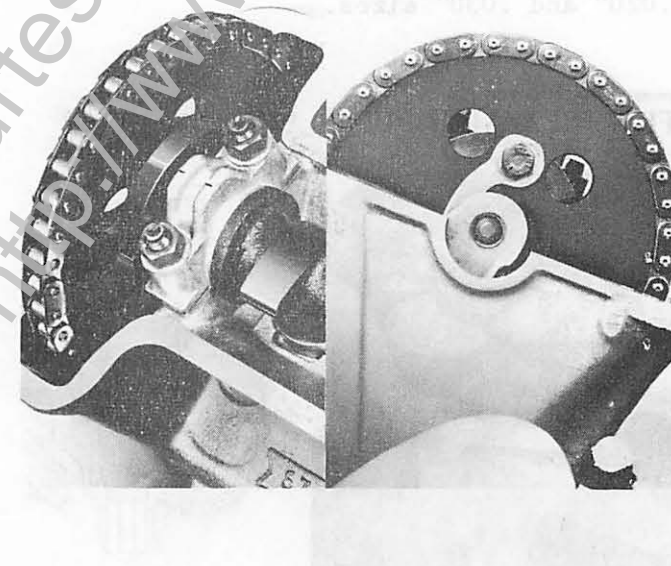
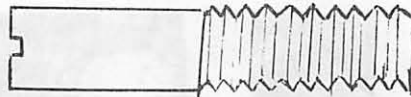

37. Fit head studs, nuts and bolts - torque studs and nuts first which will move head into the correct position - torque bolts.

CYLINDER HEAD TIGHTENING SEQUENCE

45-55lbf ft (6.2-7.6 kgf m)

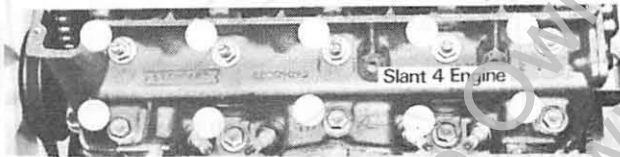

38. Align jackshaft gear as illustrated. Fit timing chain, timing wheel and top bolt and lock plate. Fit chain guides and brackets. Fit timing chain tensioner and adjust guide to give figure as illustrated.

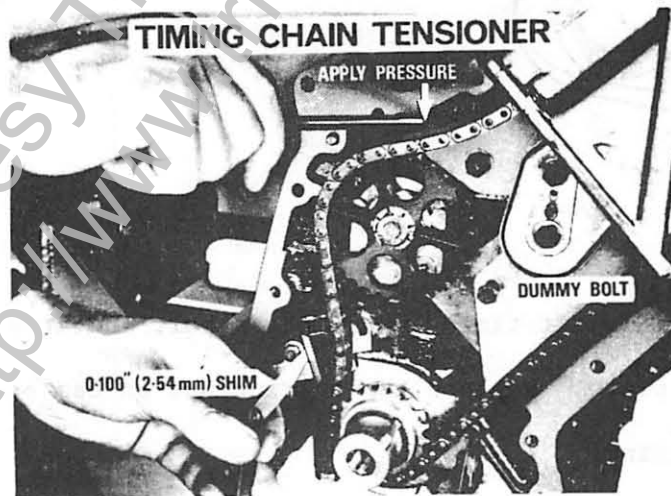

39. Fit distributor - align as illustrated:

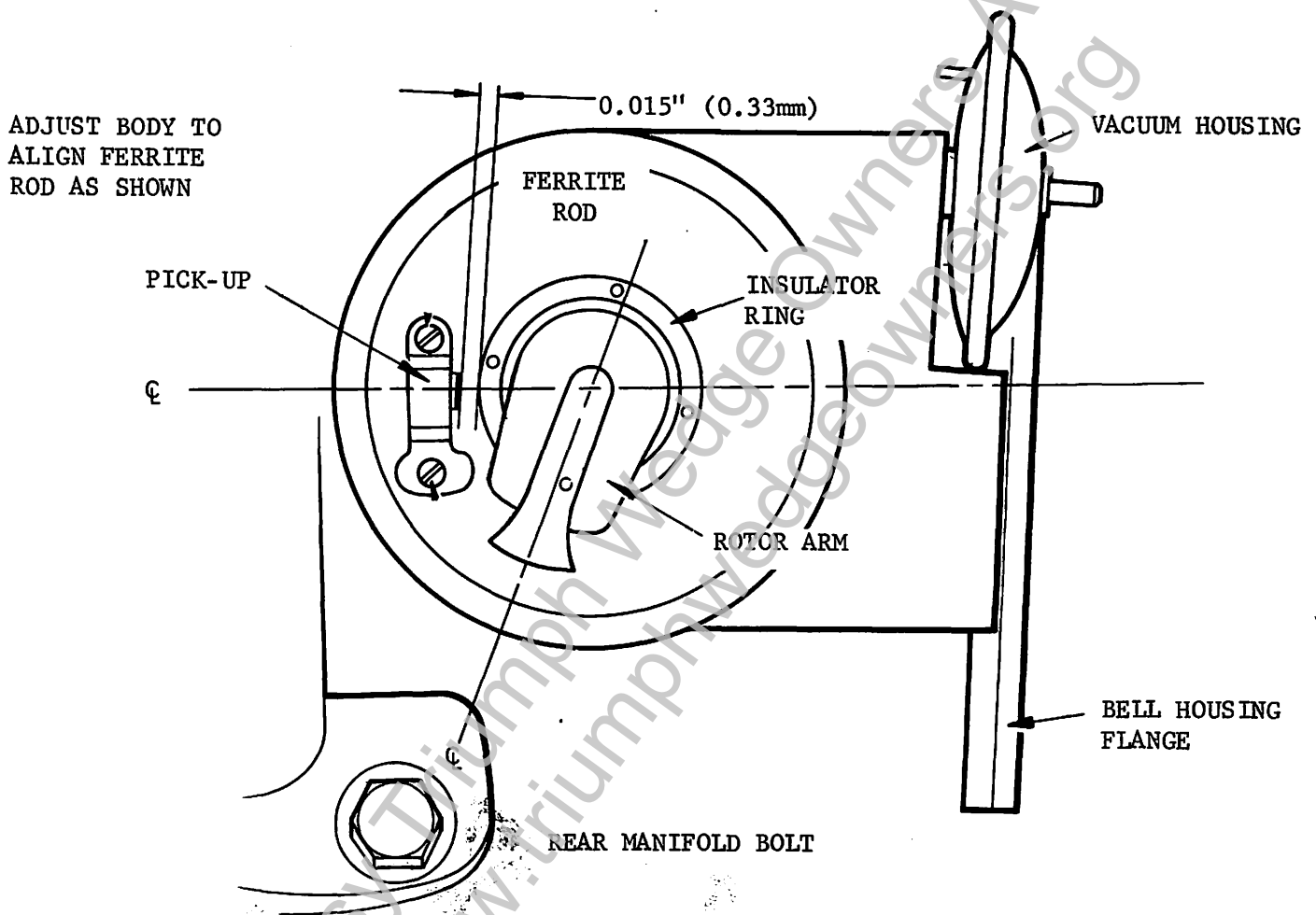

40. Rotate engine, fit timing wheel other bolt and lock both bolts with lock plate. Replace cam bearing nut on cam bearing.
41. Recheck timing.
42. Refit timing cover including oil thrower. Tighten oil pan.

43. Fit alternator and air pump brackets.
44. Fit front pulley.
45. Refit cam cover.
46. Refit fan pulley bracket.
47. Fit air injection tubes, air manifold and supply hose.
48. Fit air pump, alternator and belts.
49. Fit fan blades.